

GENERAL FEATURES

- Stainless-steel construction
- Welded seams
- Hand-finished edges
- Heavy-duty 600 CFM blower
- 4 Speed Settings
- Backlit push button control
- Stainless steel, anti-grease, baffle filters - dishwasher safe
- Magnetic grease collector
- Time delay shut-off
- Light indicator for grease filter maintenance
- Light indicator for charcoal filter replacement (if applicable)
- Convertible Ventilation (external venting or filtered recirculation)

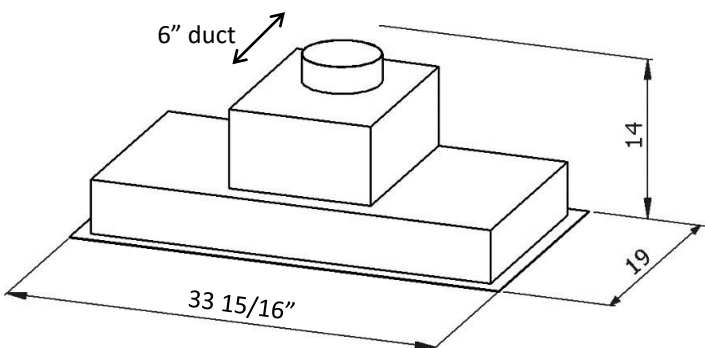

Specifications		
Model Number	VEINS34GSS	
Size	34"	
Type	Hood Insert	
Color	Stainless Steel	
Control Panel	Backlit Control w/ Stainless Steel Buttons	
Fan Speeds	4	
Lights	2 LED	
Max CFM	600	
Noise Level – Sones (dB)	3 (45 dB) – 28 (76 dB)	
Venting	Top Vented	
Duct Size	6" (150 mm)	
Power Requirements	120 Volt 60Hz. 15 Amp	
Dimensions	Width (in)	33 15/16"
	Height	14" to top of vent
	Depth (in)	19 "
	Weight	35 lbs.

Also available in a 46" width (VEINS46GSS)

